

Kit 3044

VOLKSWAGEN California (T5), 4-dr Bus, 03-09, 10-
VOLKSWAGEN Caravelle (T5), 4-dr Bus, 03-09, 10-
VOLKSWAGEN Multivan (T5), 4-dr Bus, 03-09, 10-
VOLKSWAGEN Shuttle (T5), 4-dr Bus, 03-09, 10-
VOLKSWAGEN Transporter (T5), 4-dr Van, 03-09, 10-

This Kit is only for vehicles with fixpoint mounting or T-profile.

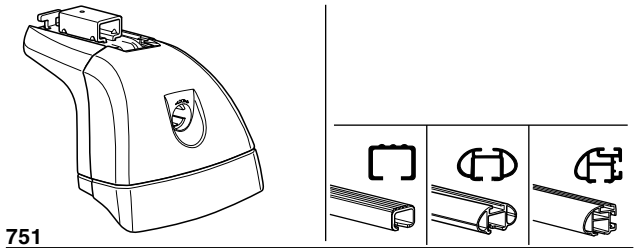

THULE[®]
SWEDEN

ISO 11154-E

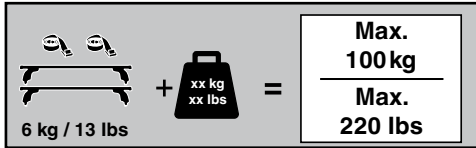

6 kg / 13 lbs + xx kg xx lbs = **Max. 100 kg**
Max. 220 lbs

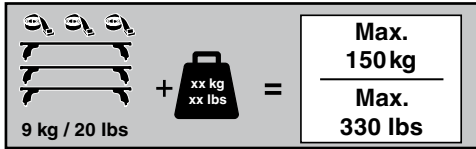

9 kg / 20 lbs + xx kg xx lbs = **Max. 150 kg**
Max. 330 lbs

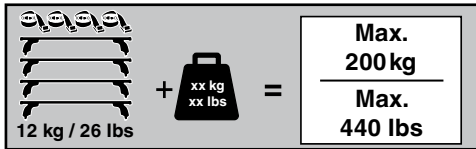

12 kg / 26 lbs + xx kg xx lbs = **Max. 200 kg**
Max. 440 lbs

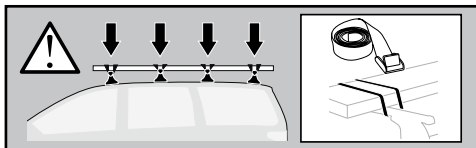
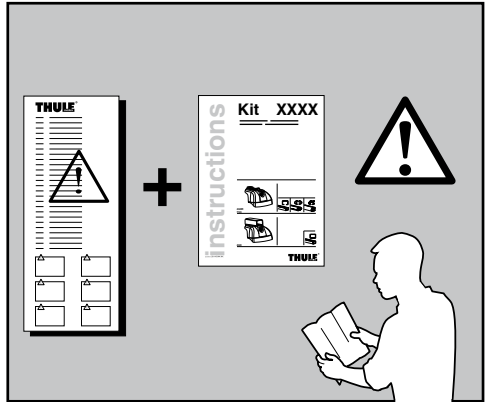
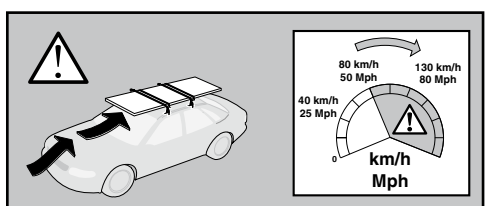
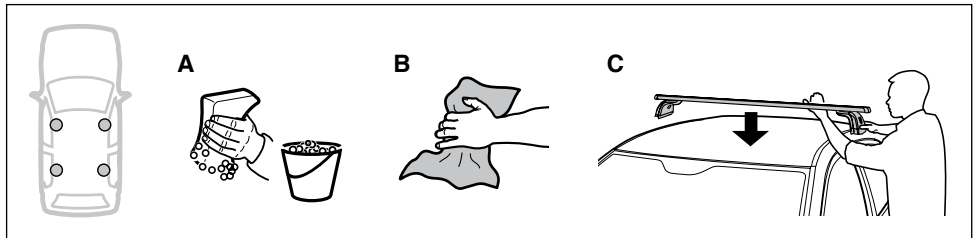
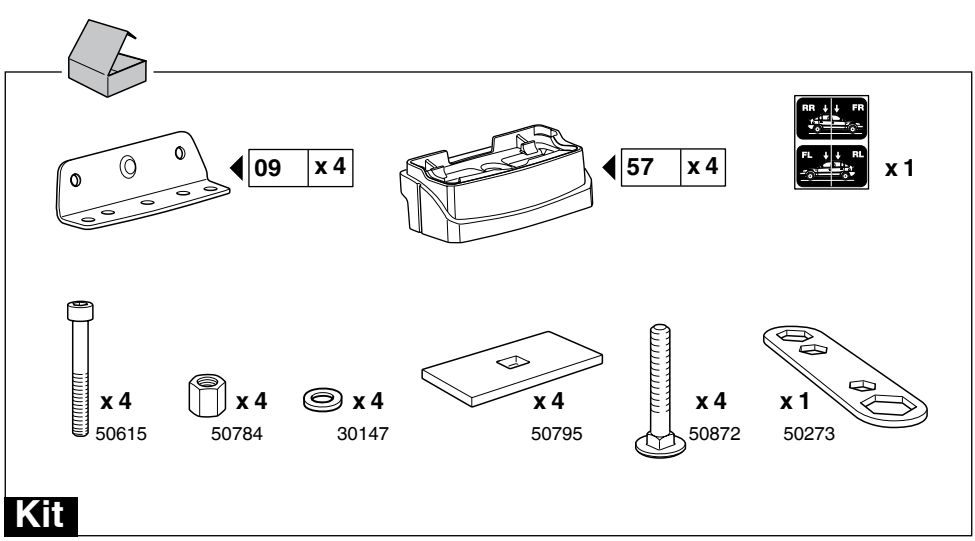
Kit

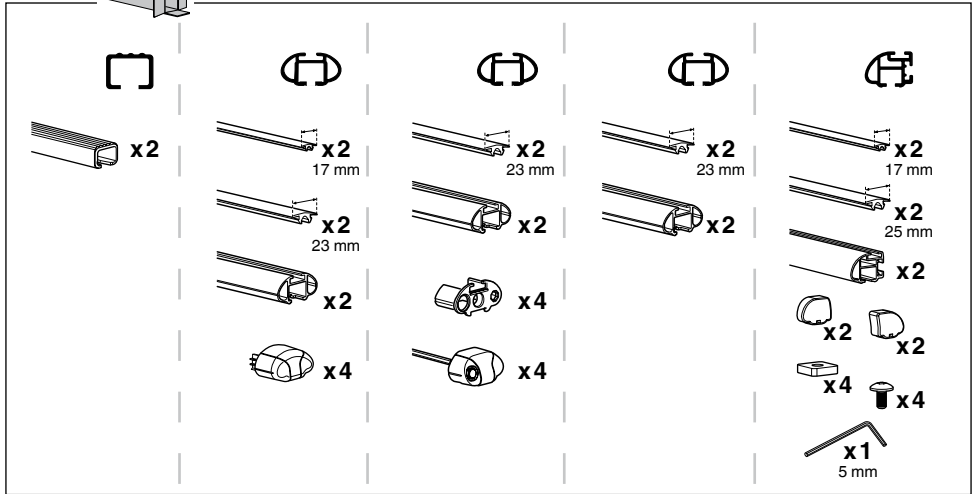
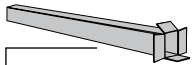
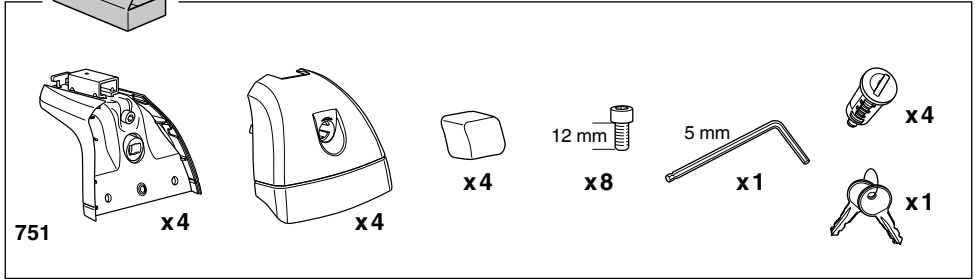

1

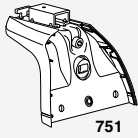

751

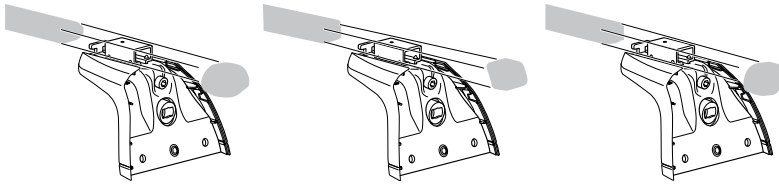

x4

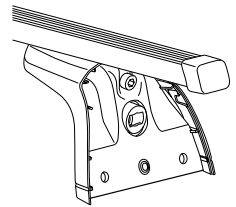
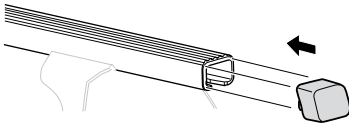

x4

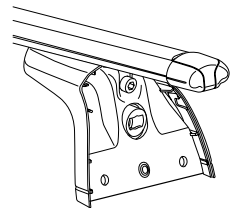
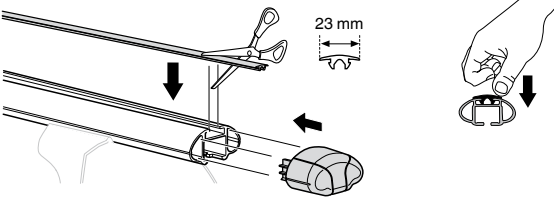

x4

x4

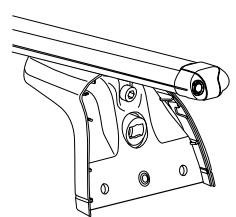
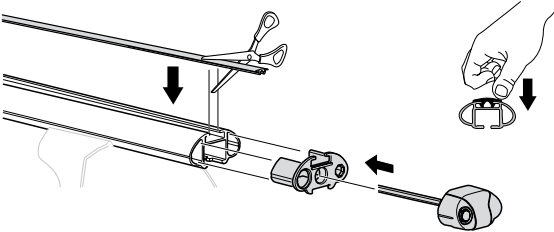

x2

x2

x4

x4

x1

5 mm

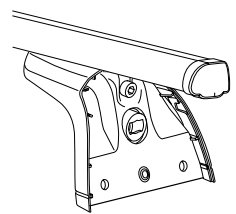
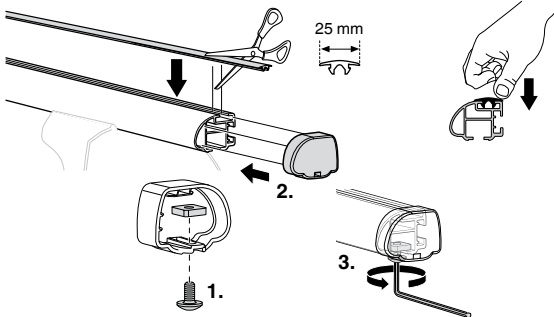

2

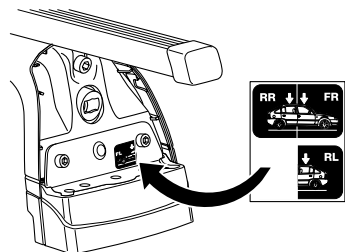
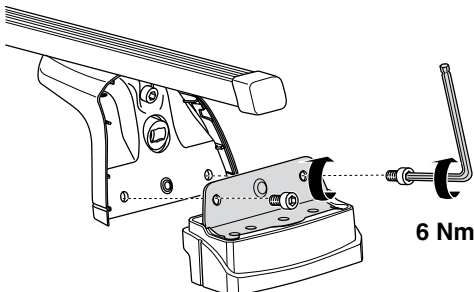
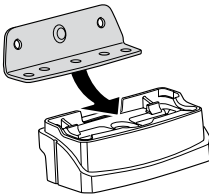
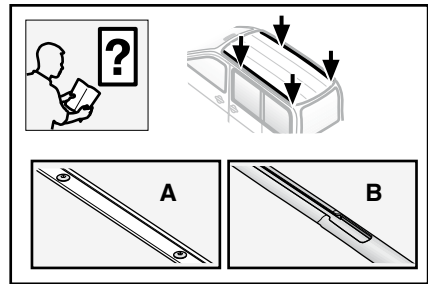
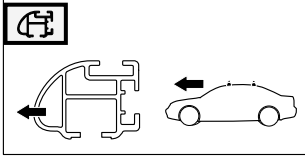
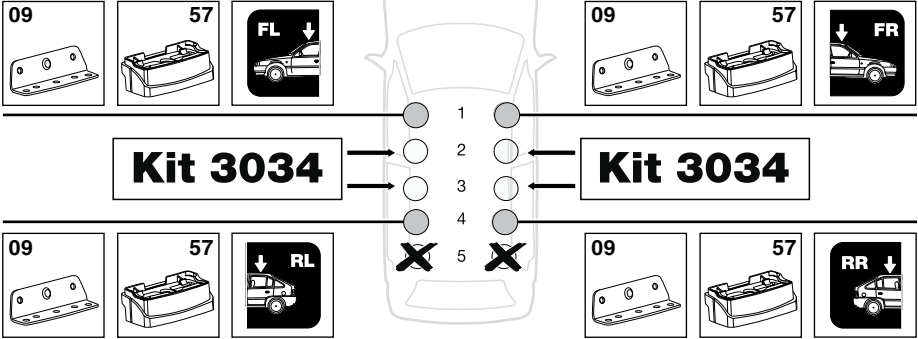
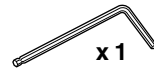
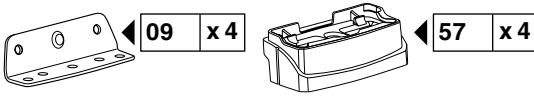

3



x4



x4

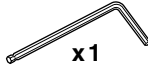

x1

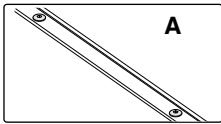
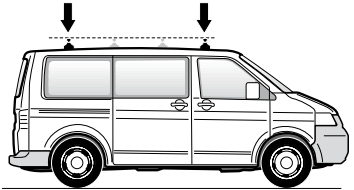

A

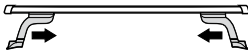
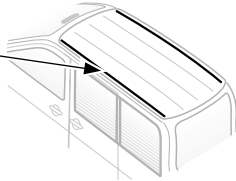

A

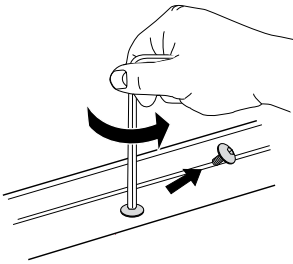

B

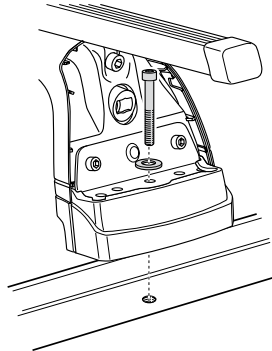

C

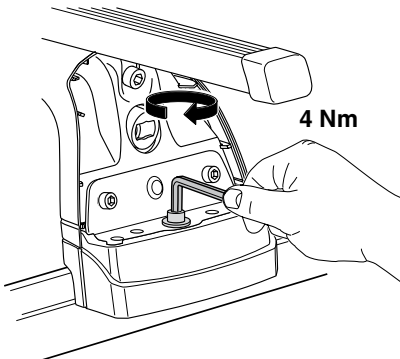

4 Nm

D

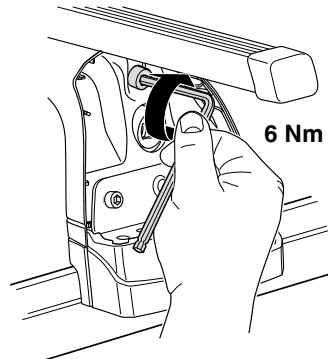

6 Nm

3

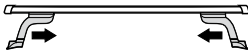
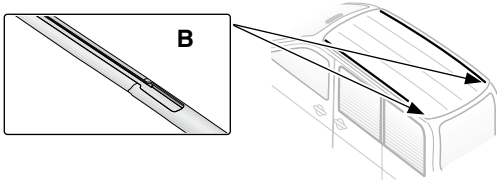
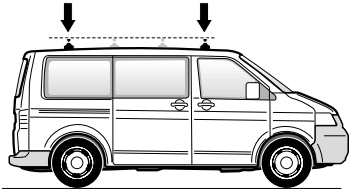
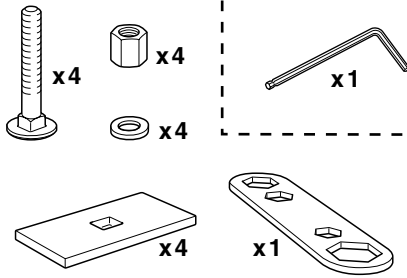

A

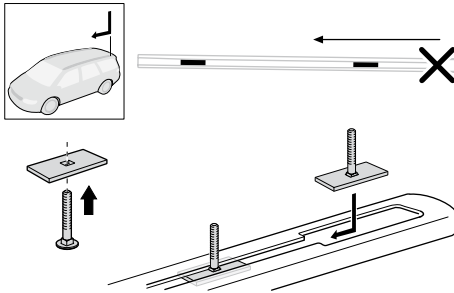

B

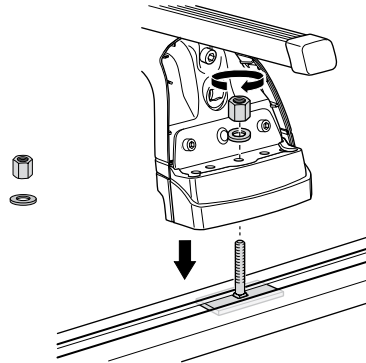

C

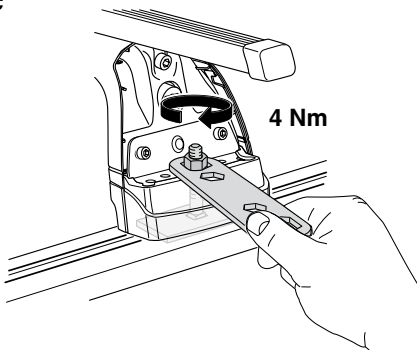

D

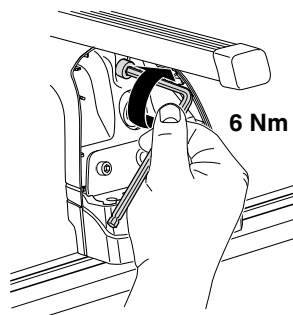

4

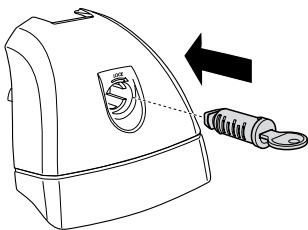

5

5 mm

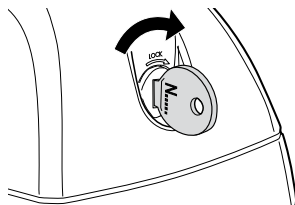
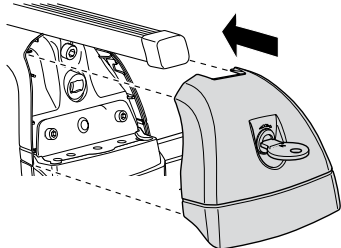
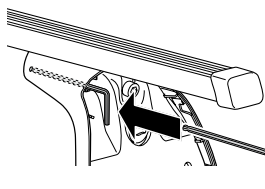

6

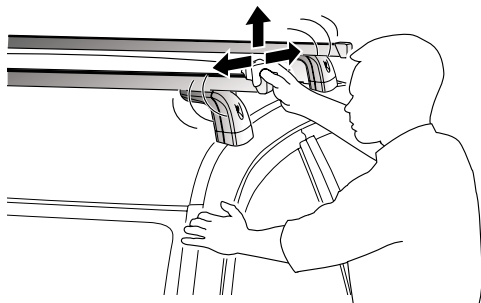

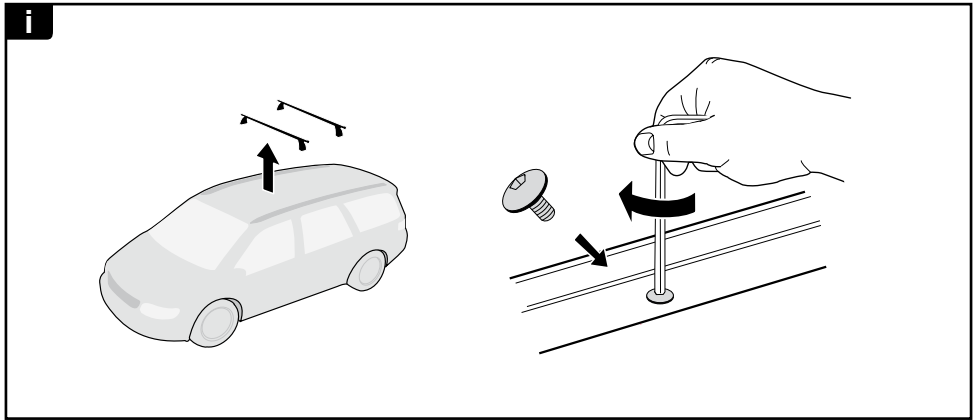
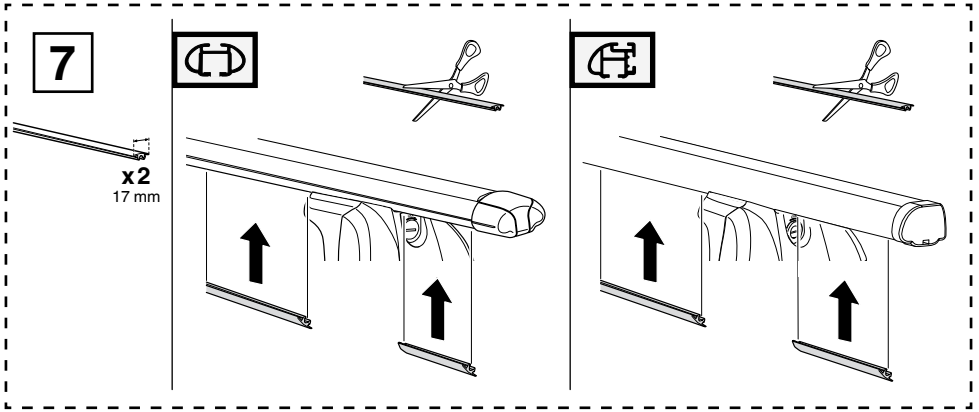

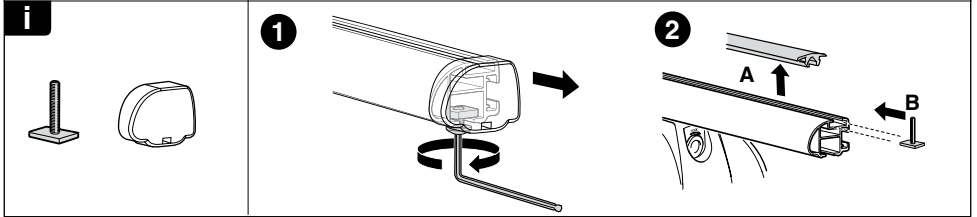
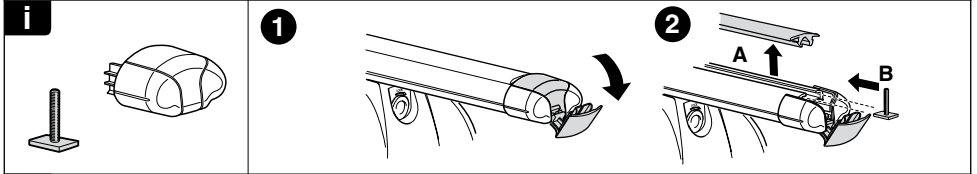
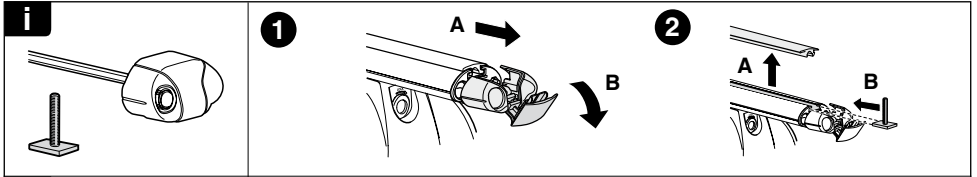
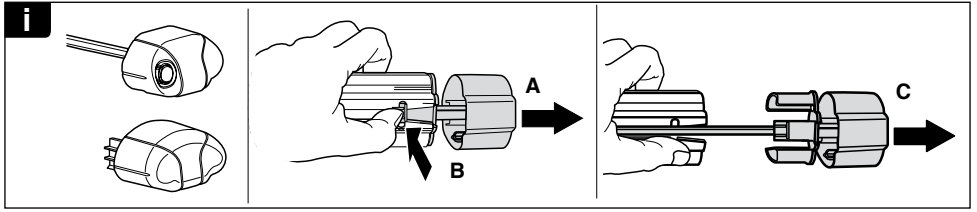

THULE
SWEDEN

**ONE
KEY
SYSTEM**

544 (x4)

596 (x6)

588 (x8)

NA 510 (x10)

EUR 452 (x12)

ASIA