

Kit 1327

HONDA City, 4-dr Sedan, 03-08

HONDA Fit Aria, 4-dr Sedan, 03-08

480R
754

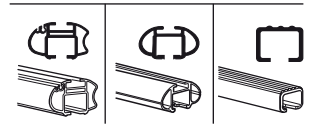
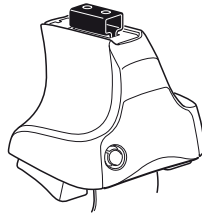

480

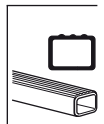
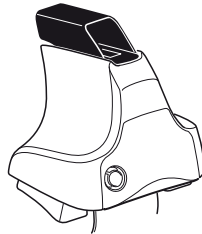

750

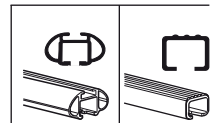
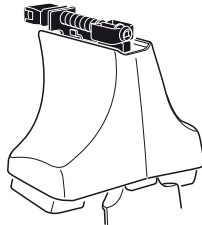



3

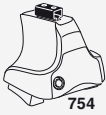

754

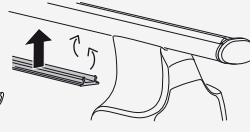
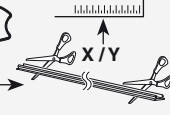

750

1

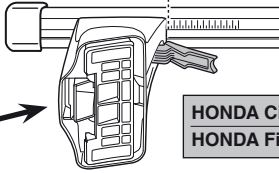
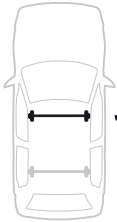

2

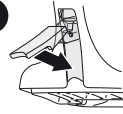

HONDA City, 4-dr Sedan, 03-08

HONDA Fit Aria, 4-dr Sedan, 03-08

X

36,5

36,5

1

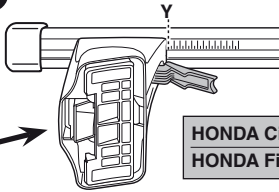

2

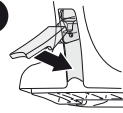

HONDA City, 4-dr Sedan, 03-08

HONDA Fit Aria, 4-dr Sedan, 03-08

Y

33

33



480R



480

1

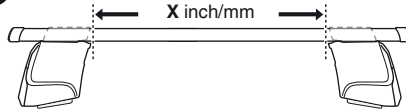

2

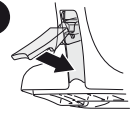

X inch

X mm

HONDA City, 4-dr Sedan, 03-08

HONDA Fit Aria, 4-dr Sedan, 03-08

40"

40"

1016 mm

1016 mm

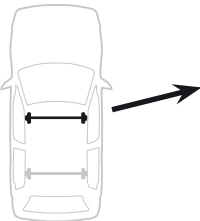

1

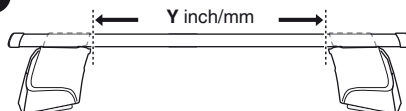

2

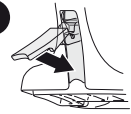

Y inch

Y mm

HONDA City, 4-dr Sedan, 03-08

HONDA Fit Aria, 4-dr Sedan, 03-08

38 5/8"

38 5/8"

981 mm

981 mm

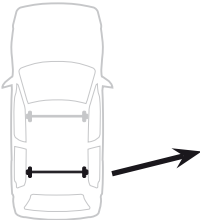

4

HONDA City, 4-dr Sedan, 03-08
 HONDA Fit Aria, 4-dr Sedan, 03-08

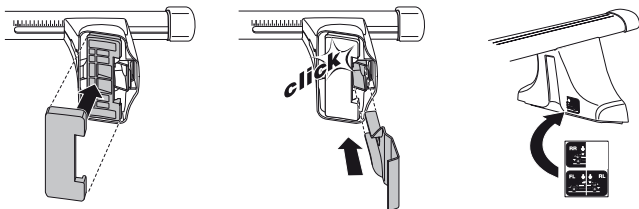
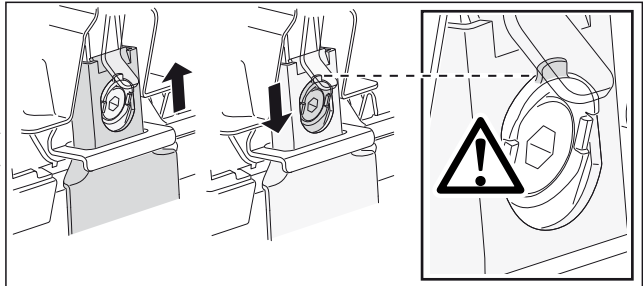
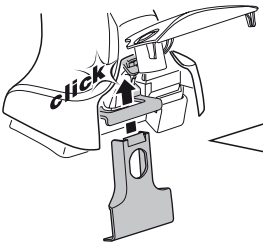
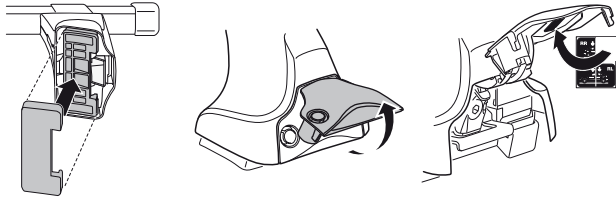
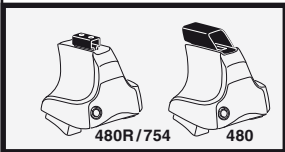
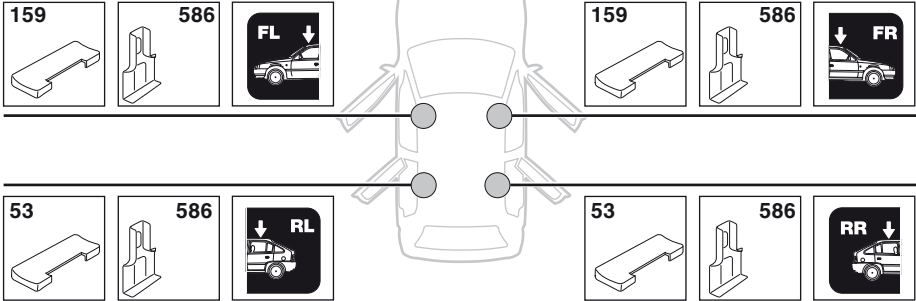

5



	X mm	Y mm	X inch	Y inch
HONDA City, 4-dr Sedan, 03-08	300 mm	615 mm	11 3/4"	24 1/4"
HONDA Fit Aria, 4-dr Sedan, 03-08	300 mm	615 mm	11 3/4"	24 1/4"

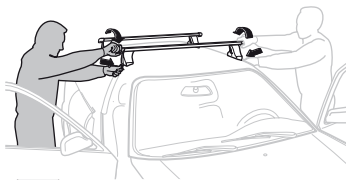
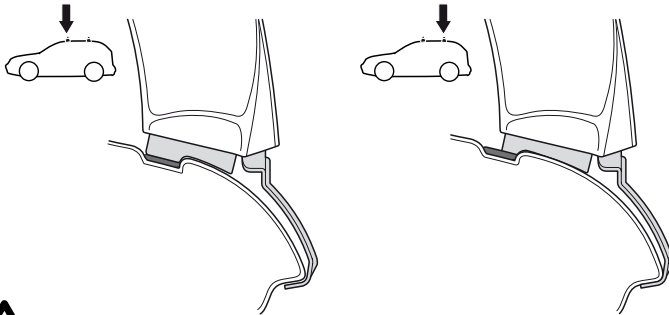
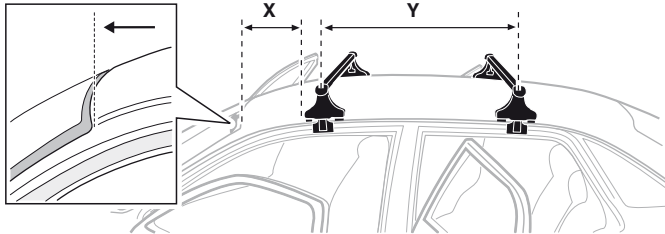

- GB/US** Tighten alternately
D Die Schrauben abwechselnd anziehen
F Serrer alternativement chaque côté
NL Afwisselend aan de linker- en de rechterkant aandraaien
I Alternare il serraggio delle viti
E Apretar alternativamente
PT Aperte alternadamente
S Dra åt växelvis

- FIN** Kierrä vuorotellen
EST Pinguldage vaheldumisi
LAT Pievelciēt pamišus
LIT Užsukinėkite pakaitomis
PL Śruby dokręcaj naprzemiennie
RU Затягивайте попеременно
CZ Pokręťta багаžníka dokręcaj dokręcaj naprzemiennie.
SK Dotahujte striedavo
SLO Privijajte izmenično.
HR Naizmjenično zategnite
HU Egymástól függetlenül szorítandó
GR Σφιγγετε εναλλάξ
TR Dönüşümlü sıkın
中文 交替拧紧
한국어 번갈아 가며 조이십시오.
日本語 交互に締め付けてください。
ไทย ชับในแบบสลับ

6



480R/754



480

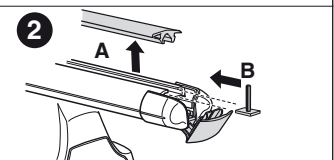
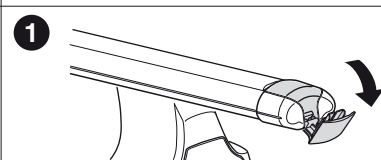
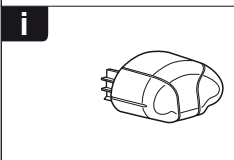
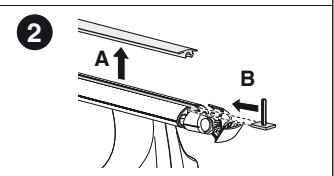
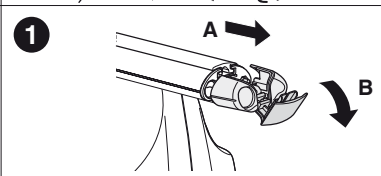
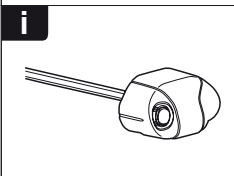
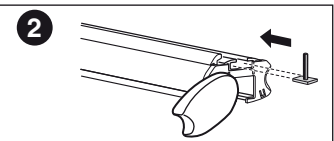
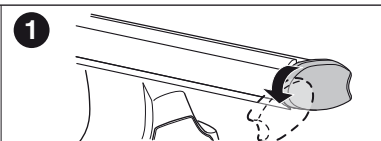
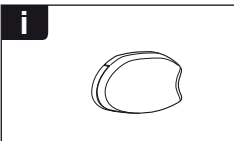
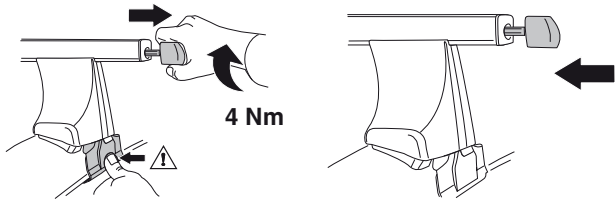
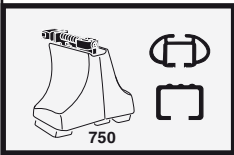
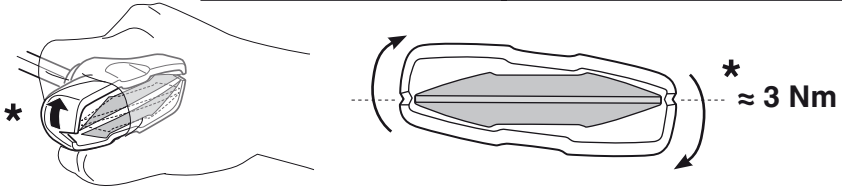
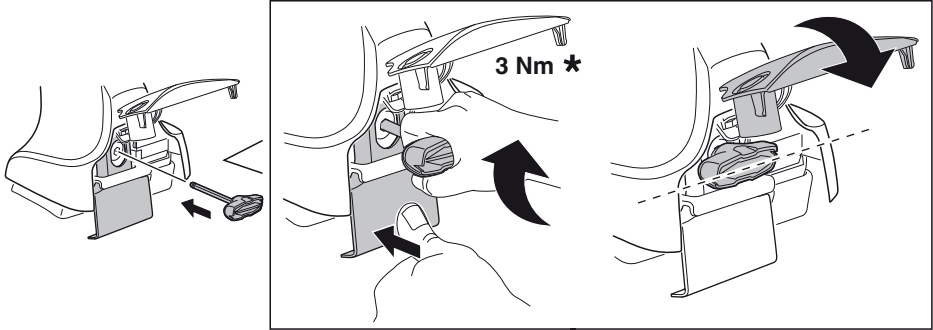



THULE
SWEDEN
**ONE
KEY
SYSTEM**



- 544 (x4)
- 596 (x6)
- 588 (x8)
- NA 510 (x10)
- EUR 452 (x12)
- ASIA



WW ▶ Thule Sweden AB, Box 69, 330 33 Hillerstorp, SWEDEN
NA ▶ Thule Inc., 42 Silvermine Road, Seymour, Connecticut 06483, USA

info@thule.com
customer.service@thule.com

www.thule.com