

# Kit 1066

HONDA Stepwagon, 5-dr MPV, 96-00

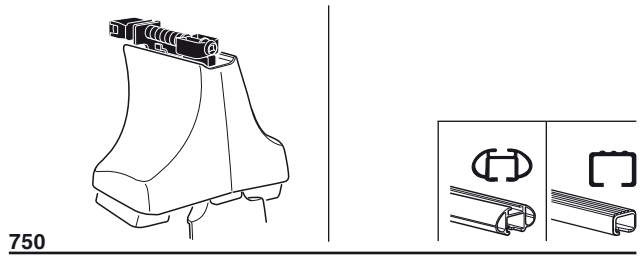
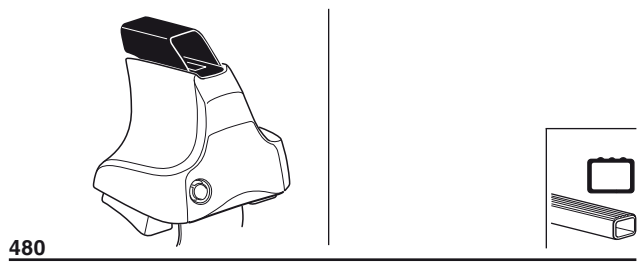
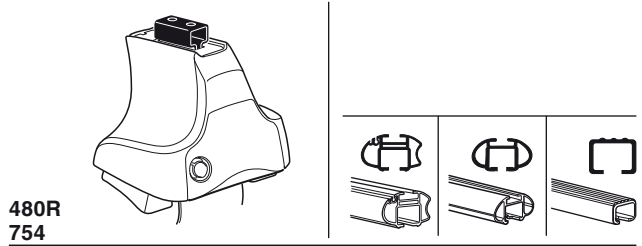

**Max. 75kg**  
**Max. 165 lbs**

**Kit XXXX**  
 instructions

x1

x4

x4

x4  
 x4

**480R/754**

---

x1

x4

x4

x4

**480**

---

x1

x4

x4

**750**

x2 x2 x2 x4	x2	x2 x2 x4 x4	x2 x2 x2	x2
----------------------	----	----------------------	----------------	----

**171** x4

**44** x4

x8

x8

x1

x1

**Kit**



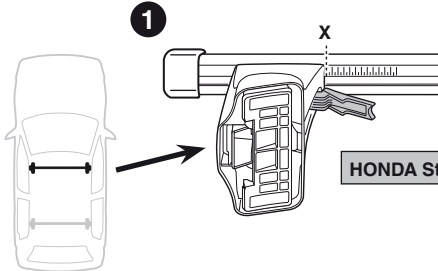

HONDA Stepwagon, 5-dr MPV, 96-00	X
	31,5

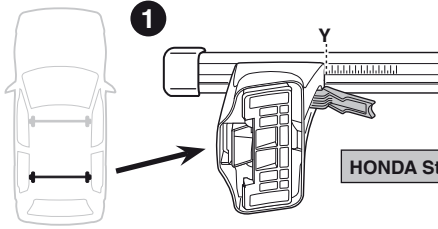

HONDA Stepwagon, 5-dr MPV, 96-00	Y
	31,5

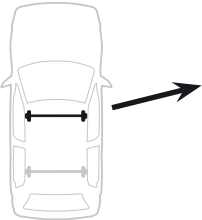
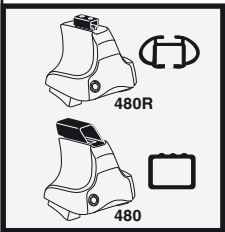

HONDA Stepwagon, 5-dr MPV, 96-00	X inch	X mm
	38"	966 mm

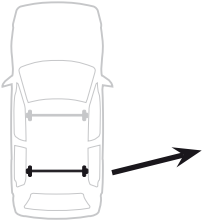

HONDA Stepwagon, 5-dr MPV, 96-00	Y inch	Y mm
	38"	966 mm



4

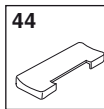
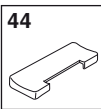
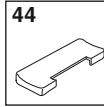
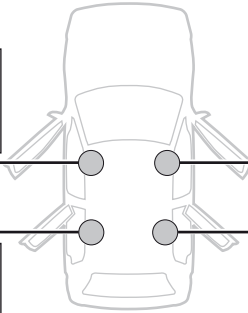
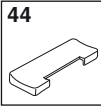
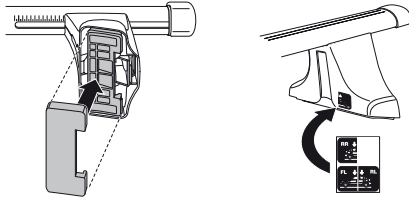
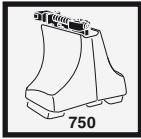
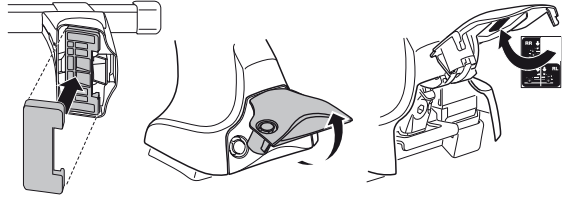
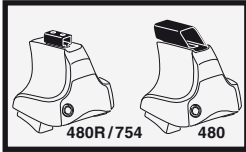

5

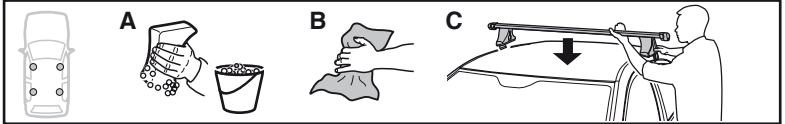

x 4

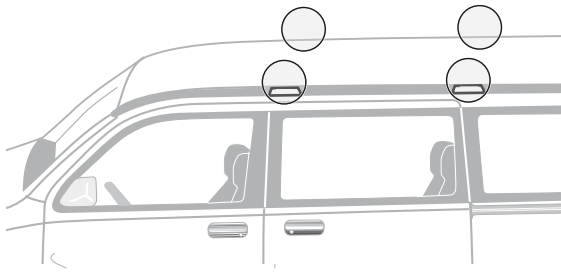
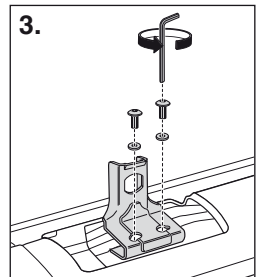
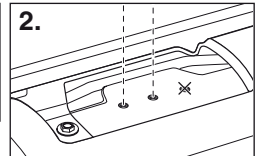
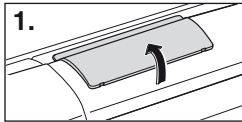

6

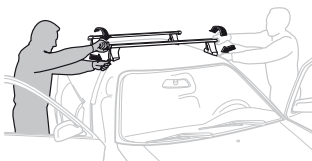
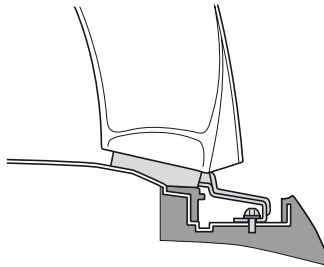
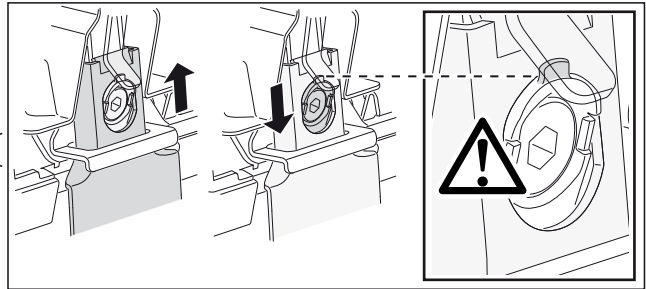
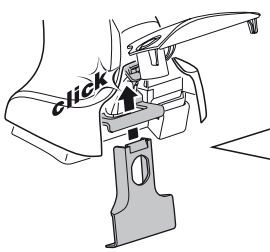
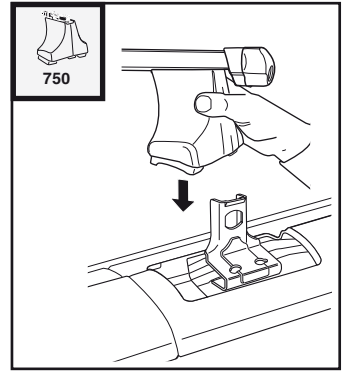
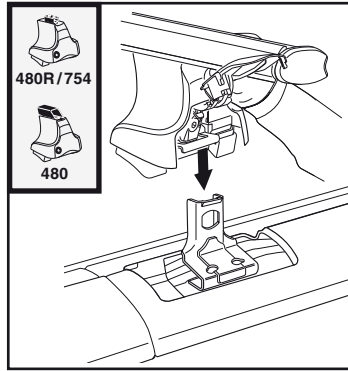

- GB/US** Tighten alternately  
**D** Die Schrauben abwechselnd anziehen  
**F** Serrer alternativement chaque côté  
**NL** Afwisselend aan de linker- en de rechterkant aandraaien  
**I** Alternare il serraggio delle viti  
**E** Apretar alternativamente  
**PT** Aperte alternadamente  
**S** Dra åt växelvis  
**FIN** Kierrä vuorotellen  
**EST** Pinguldage vaheldumisi  
**LAT** Pievelciēt pamišus  
**LIT** Užsukinėkite pakaitomis  
**PL** Śruby dokręcaj naprzemiennie  
**RU** Затягивайте попеременно

- CZ** Pokręťta bagażnika dokręcaj naprzemiennie.  
**SK** Dofahujte striedavo  
**SLO** Privijajte izmenično.  
**HR** Naizmjenično zategnite  
**HU** Egymástól függetlenül szorítandó  
**GR** Σφιγγετε εναλλάξ  
**TR** Dönüşümlü sıkın

**中文** 交替拧紧

**한국어** 번갈아 가며 조이십시오.

**日本語** 交互に締め付けてください。

**ไทย** ชั้สลับแบบสลับ

6



480R/754



480

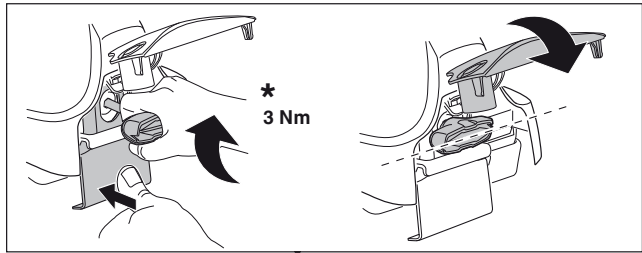
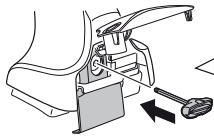

\*  
3 Nm



\*

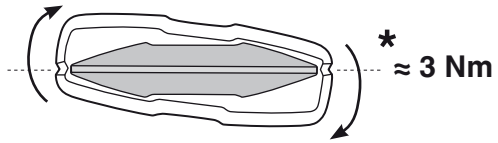

\*  
≈ 3 Nm

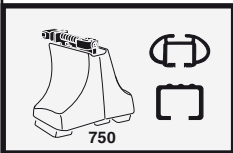
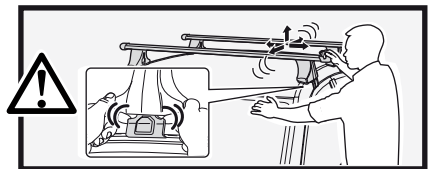

750

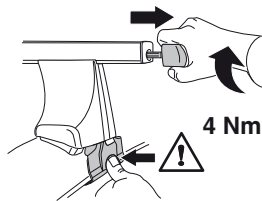

4 Nm

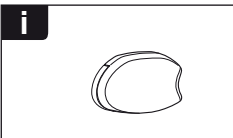
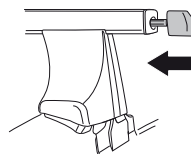

i

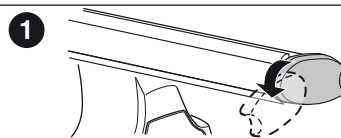

1

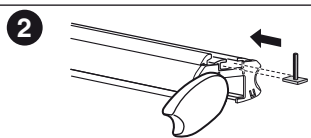

2

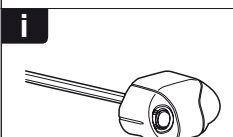

i

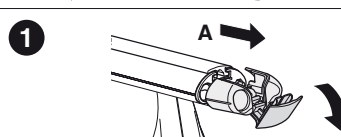

1

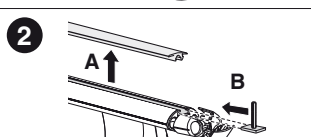

2

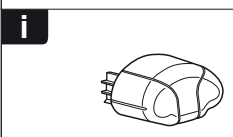

i

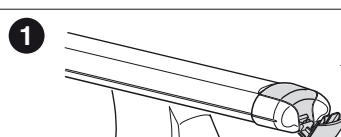

1

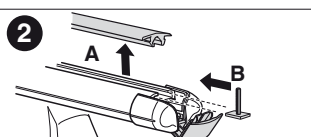



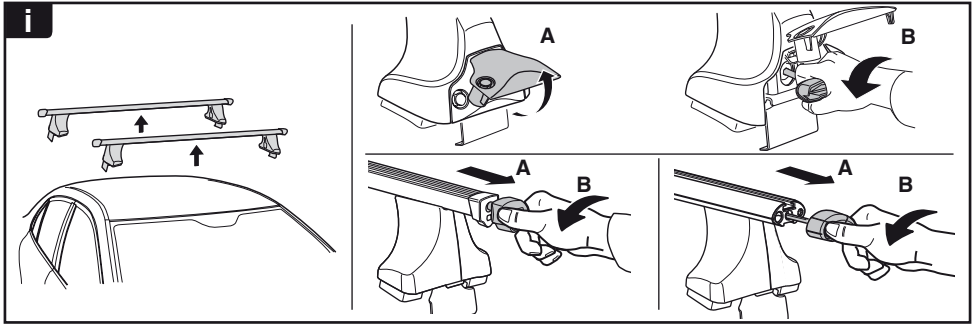

2

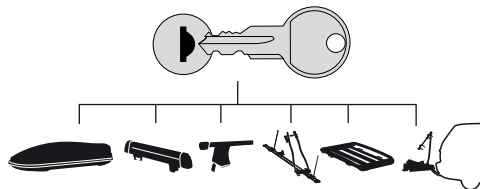

**THULE**  
SWEDEN  
**ONE  
KEY  
SYSTEM**



-  **544** (x4)
  -  **596** (x6)
  -  **588** (x8)
  -  **510** (x10)
  -  **452** (x12)
- NA  
EUR  
ASIA

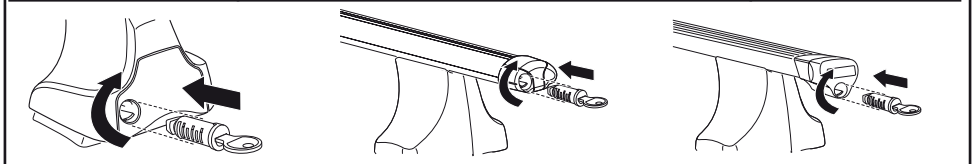

WW ▶ Thule Sweden AB, Box 69, 330 33 Hillerstorp, SWEDEN  
NA ▶ Thule Inc., 42 Silvermine Road, Seymour, Connecticut 06483, USA

info@thule.com  
customer.service@thule.com

 www.thule.com